

Številka modela:  
2312-320-84

# ESENA

## RTV 2D1S

Tip  
320

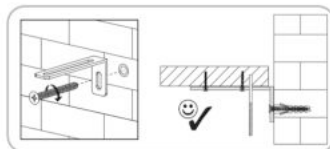
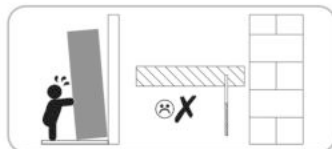
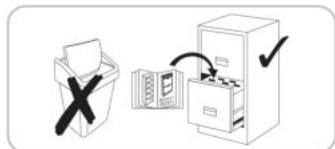
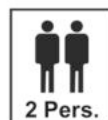
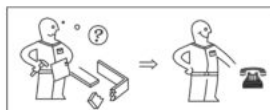
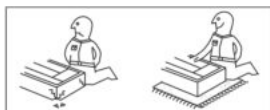
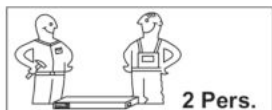

Ø8

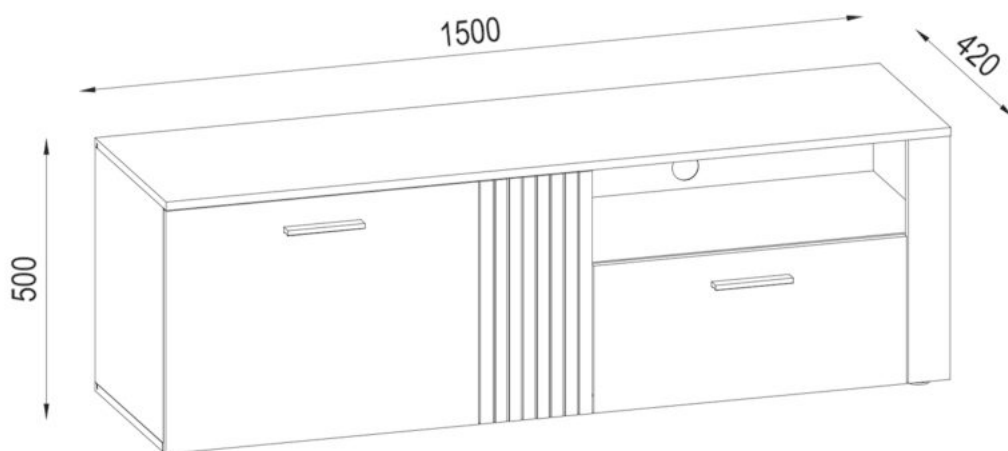

trdno pritegniti



vtisniti



izmeriti



vtisniti



bevern



Otocte - obratne

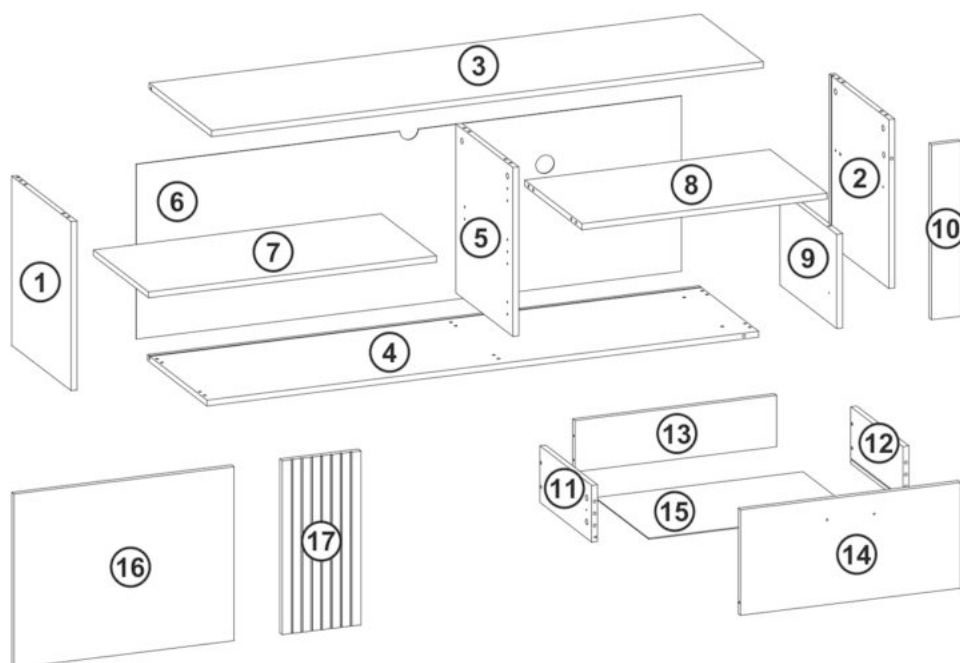















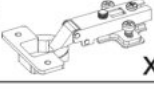





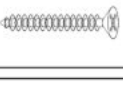



max. 3KG = 15    max. 5KG = 7 8    max. 10KG = 3 4

A	B (mm)		C	D
1	448	400	16	x1 1/2
2	448	400	16	x1 1/2
3	1500	420	16	x1 2/2
4	1500	400	16	x1 2/2
5	448	384	16	x1 1/2
6	464	1482	2,5	x1 2/2
7	783	370	16	x1 2/2
8	667	384	16	x1 2/2
9	250	384	16	x1 1/2

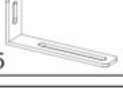
A	B (mm)		C	D
10	464	80	16	x1 2/2
11	350	150	16	x1 1/2
12	350	150	16	x1 1/2
13	548	136	16	x1 2/2
14	598	280	16	x1 2/2
15	564	358	2,5	x1 1/2
16	598	461	16	x1 1/2
17	461	214	16	x1 1/2
B1				1/2



<b>A1</b> 15x12  x16	<b>C2</b> 44mm  x16	<b>B2</b> 8x30  x22
<b>FA1</b> 4mm  x1	<b>F3</b> 6,3x50  x10	<b>O3</b> Ø18  x6
<b>K6</b> Ø35  x4	<b>J65</b> 128/148  x2	<b>O4</b> Ø18  x5
<b>M1</b> 10x10x15  x10	<b>P14</b> 45x20  x5	<b>N1</b> Ø6  x4
<b>D25</b> 4x25  x5	<b>DA21</b> 4,2x16  x8	<b>DB2</b> 4x25  x4
<b>E5</b> 5x11  x4	<b>D11</b> 3,5x16  x10	<b>D10</b> 3x16  x4
<b>R10</b> Ø10  x2	<b>I6</b> 350  x1	<b>Y36</b> 75x32x15  x1
	<b>Y37</b> 8x50  x1	<b>Y35</b> 4,2x65  x1
		<b>R6</b>  x1

Spoštovana stranka, zahvaljujemo se vam za nakup pohištva iz našega notranjega programa za izključno uporabo v zasebnih prostorih. Prosimo, da preverite popolnost obsega dobave in pred namestitvijo natančno preberete naslednje pomembne informacije ter jih shranite za poznejšo uporabo, tudi s strani tretjih oseb. Naše pohištvo je treba uporabljati v skladu s predpisi. Uporaba v nasprotju s predpisi lahko povzroči materialno škodo in v določenih okoliščinah tudi telesne poškodbe. Pohištvo ni igrača. Proizvajalec ali prodajalec ne prevzemata jamstva za škodo, ki nastane zaradi uporabe v nasprotju s predpisi ali nepravilnega ravnanja.

**OPOZORILO:** Otroci ali osebe z motnjami v duševnem razvoju se morajo ves čas izogibati delom pohištva, konicastim predmetom, majhnim delom in embalaži, saj obstaja nevarnost poškodb in/ali zadužitve.

**MONTAŽA:** Pri sestavljanju upoštevajte naša navodila za uporabo, delovanje, namestitvev ali montažo ter bodite posebej pozorni na opozorila in varnostna navodila. Neupoštevanje navodil lahko povzroči telesne poškodbe ali poškodbe pohištva/varnostne nevarnosti. Če imate kakršne koli težave pri namestitvi/montaži, se obrnite na našo servisno službo. Z veseljem vam bodo svetovali in pomagali. Namestitev lahko opravi le usposobljeno osebe. Ne prevzemamo nobene odgovornosti za škodo, če so na izdelku/delu/delah izdelka opravljene spremembe ali če so zamenjani ali uporabljeni deli/potrošni material, ki ne izvirajo od proizvajalca/prodajalca. Če so z blagom dobavljeni stenski pritrdilni elementi, kot so zatiči in vijaki, so ti namenjeni samo za uporabo na stenah iz trdnih in homogenih materialov. Pritrditev je tako dobra kot povezava med pritrditvijo in steno. Pred pritrditvijo morate preveriti primernost stene za stoječe in viseče pohištvo ter uporabiti le primerne pritrdilne elemente. Pred vsakim nameščanjem se prepričajte, da v prostoru za dobrodošlico ni električnih žic. Na koncu je za pritrditev stene odgovoren monter.

To velja tudi za vgradnjo električnih izdelkov in drugih gradbeno-tehničnih pripomočkov. Montažo/vgradnjo električnih izdelkov in drugih pomembnih gradbeno-tehničnih pripomočkov lahko izvaja le pooblaščen usposobljeno osebe. Vse električne in gradbeno-tehnične inštalacije morajo biti izvedene v skladu z veljavnimi standardi in varnostnimi predpisi v vaši državi. Pri svetlobnih virih uporabljajte le dovoljeno jakost osvetlitve. Neupoštevanje največjega števila vatov lahko povzroči nevarnost požara zaradi pregrevanja. Zaradi nevarnosti požara prekrivanje svetilk ni dovoljeno. Popolno delovanje pohištva je zagotovljeno le pri navpični in vodoravni namestitvi. Vrata so vnaprej nastavljena, vendar jih je mogoče glede na lokalne razmere ponovno nastaviti. Upoštevajte podatke o teži za največjo obremenitev. Na pohištvo se ne sme plezati. Ob nestrokovni uporabi se lahko pohištvo prevrne. Da bi to preprečili, je treba pohištvo vedno zavarovati pred prevrnitvijo. Pri preobremenitvi/preveliki obremenitvi (zlasti zaradi igranja otrok, ljudi, materialov ali drugih neprimeren vplivov) obstaja nevarnost zloma in poškodb. Vse vijake in podporne priključne točke je treba po 5 do 6 tednih zategniti, da se zagotovi trajna stabilnost.

**SKRB ZA POHIŠTVO**—Da bi v našem izdelku uživali čim dlje, upoštevajte naša navodila za pravilno nego pohištva. Pri čiščenju uporabljajte čisto, suho in mehko bombažno krpo. Če pohištvo potrebuje temeljito čiščenje, lahko krpo navlažite z malo vode ali čistilom za pohištvo in nato očiščene dele posušite. Kovinske in steklene dele je najbolje očistiti s komercialno dostopnimi čistili za kovine in steklo v skladu z navodili na izdelku. Na čistilih mora biti jasno navedeno, da so primerna za čiščenje pohištva. Nikakor ne uporabljajte parnih čistil, kavstičnih sredstev, abrazivnih sredstev ali drugih izdelkov, katerih učinkov ne poznate. **POZOR:** Površine z visokim sijajem so ob dobavi zaščitene z zaščitno folijo. Folijo pustite na pohištvu, dokler ni popolnoma sestavljeno in očiščeno prahu. Predmete z visokim sijajem, s katerih je bila odstranjena zaščitna folija, lahko očistite in uporabite šele po 72 urah (čas za naknadno strjevanje na zunanjem zraku). Površin ne smete poškodovati z ostrimi predmeti in jih nikoli ne smete izpostavljati močni sončni svetlobi.

**LIKVIDACIJA**— Navodila za odstranjevanje odpadkov —

Za zaščito okolja odpadno embalažo odlagajte ločeno po vrstah v za to namenjene smetnjake/koše za recikliranje in je v nobenem primeru ne odlagajte v okolje. Poškodovano ali neuporabno pohištvo lahko pošljete v posebne zbirne centre za recikliranje posameznih delov. Rabljenega, a še vedno funkcionalnega pohištva ni treba takoj odstraniti. Podarite ga na primer dobrodelnim organizacijam. Želimo vam veliko veselja z novim pohištvom.

# 1

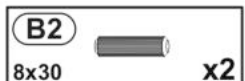
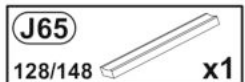
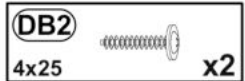
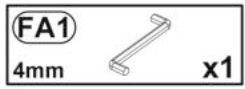
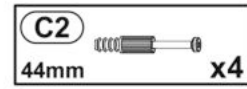
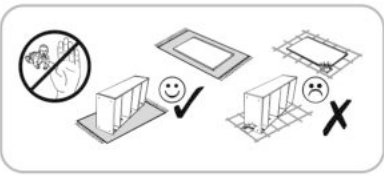

## A

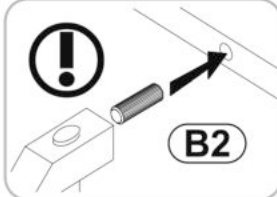
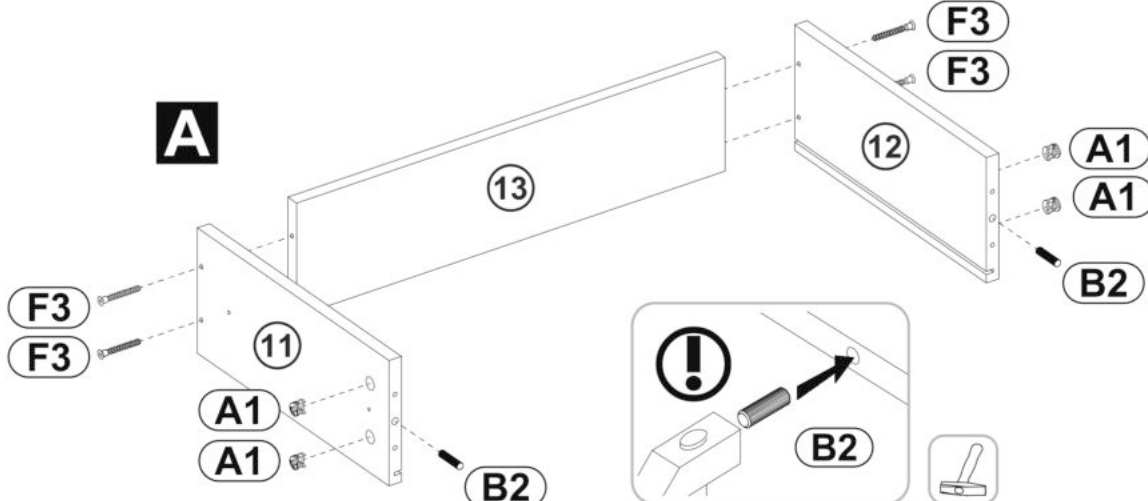

## B

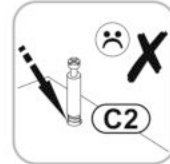
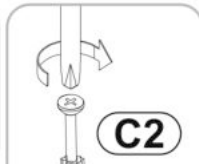
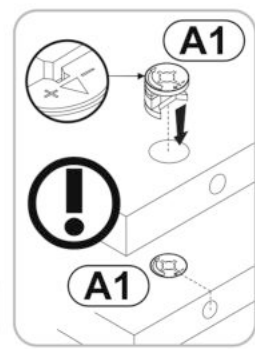
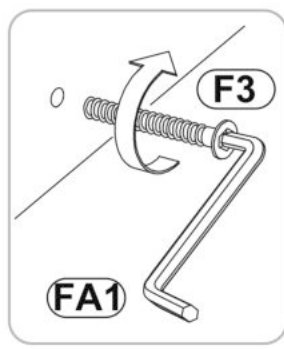
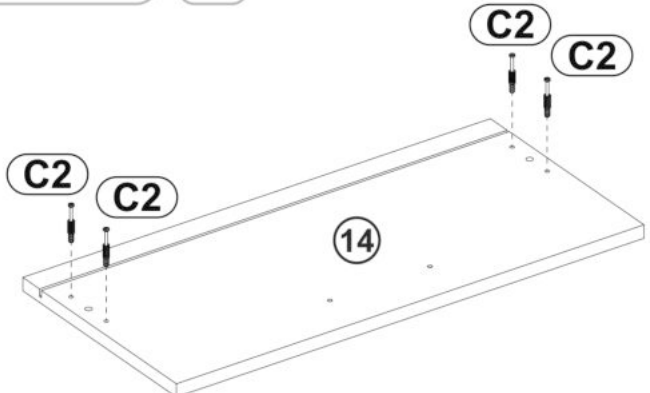

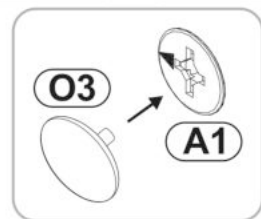
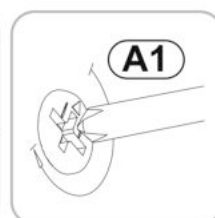
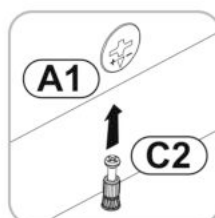
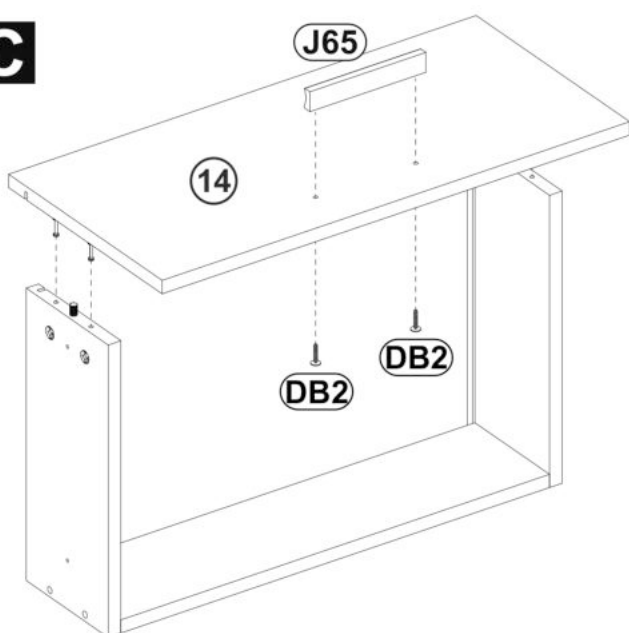

## C

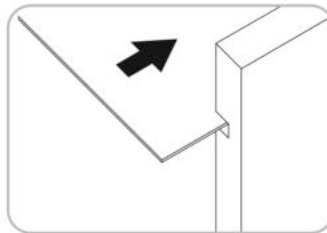
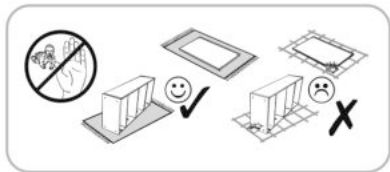

# 2



<b>DA21</b> 4,2x16		<b>x4</b>
<b>I6</b> 350		<b>x1</b>
<b>D10</b> 3,0x16		<b>x4</b>

## D

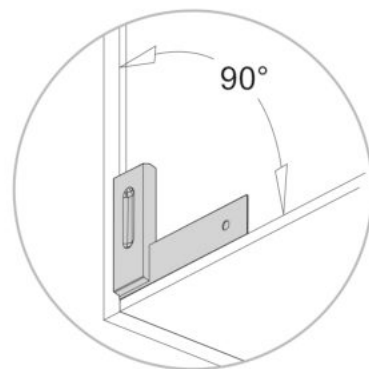
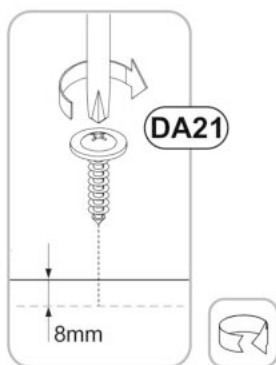
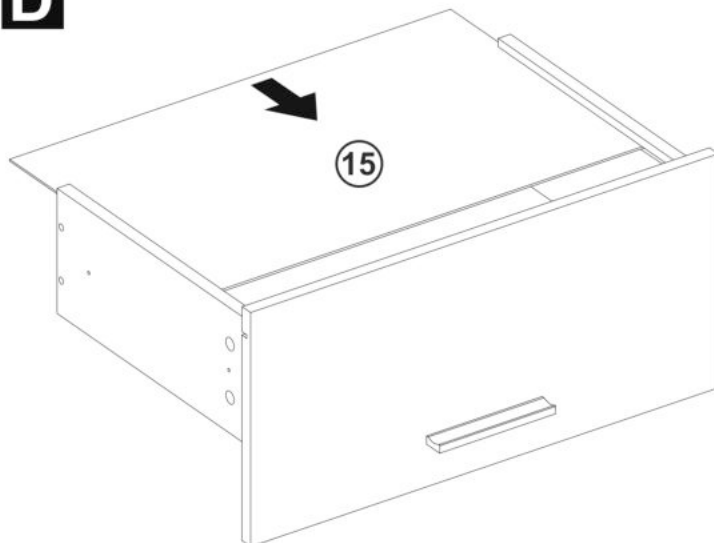

**A=B**

## E

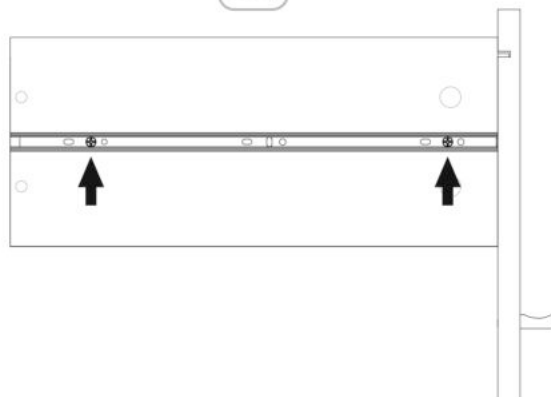
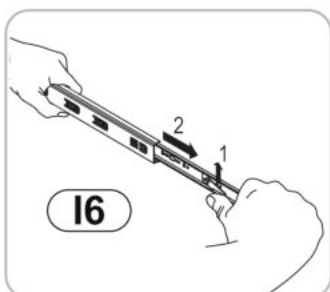
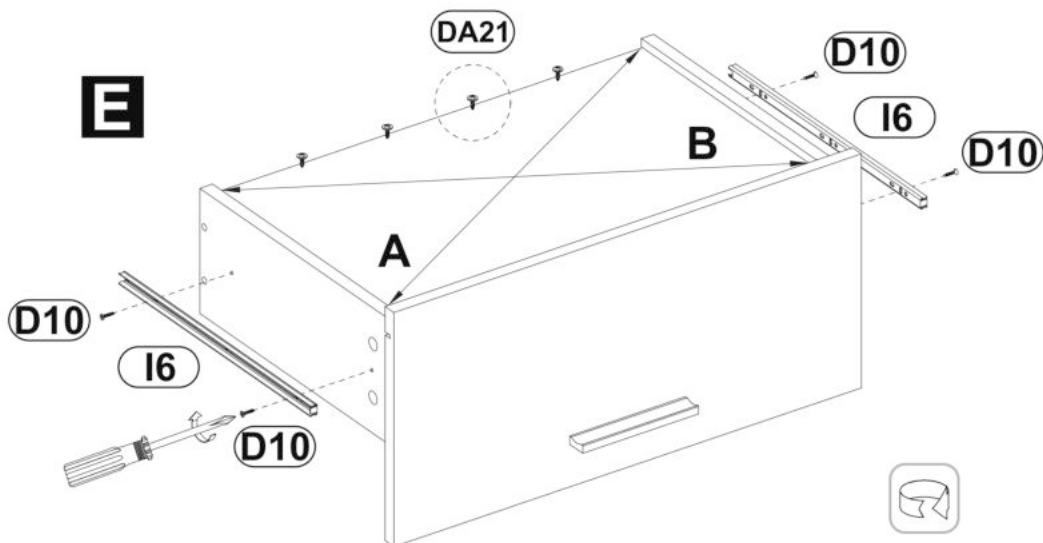

# 3

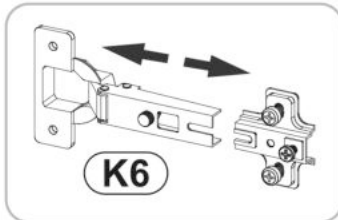
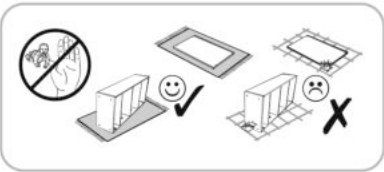

**A1**  
15x12 x9

**B2**  
8x30 x12

**K6**  
Ø35 x2

**C2**  
44mm x2

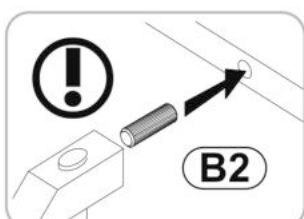
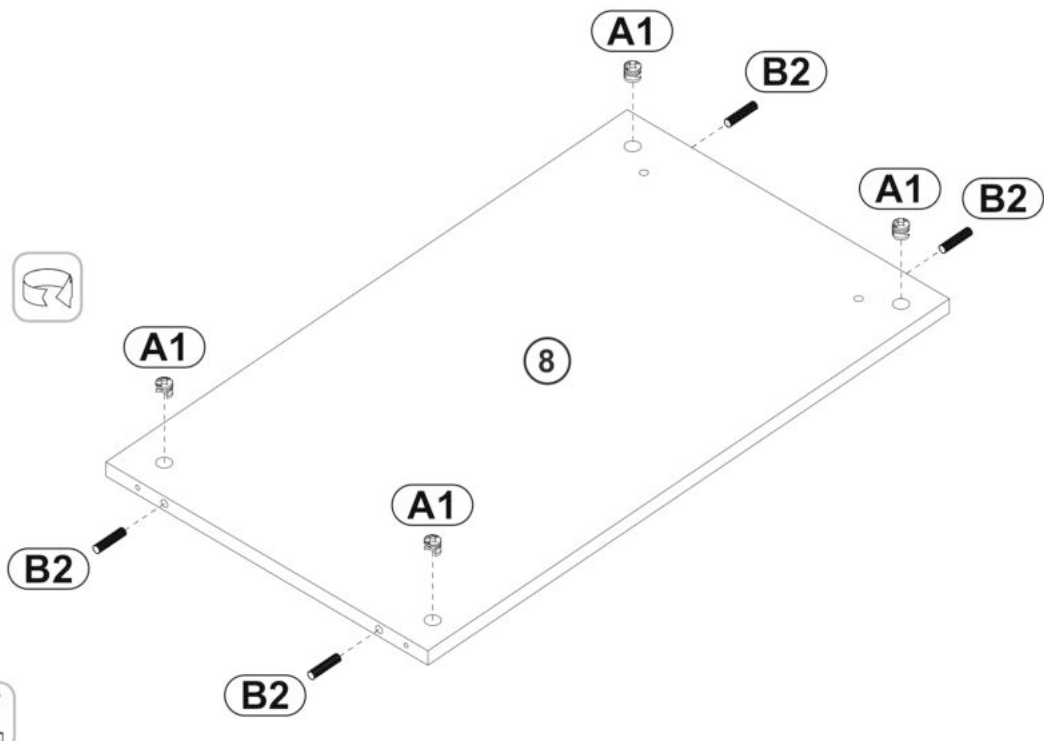
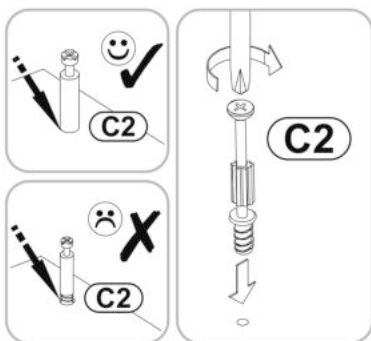
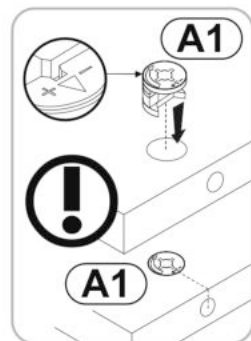
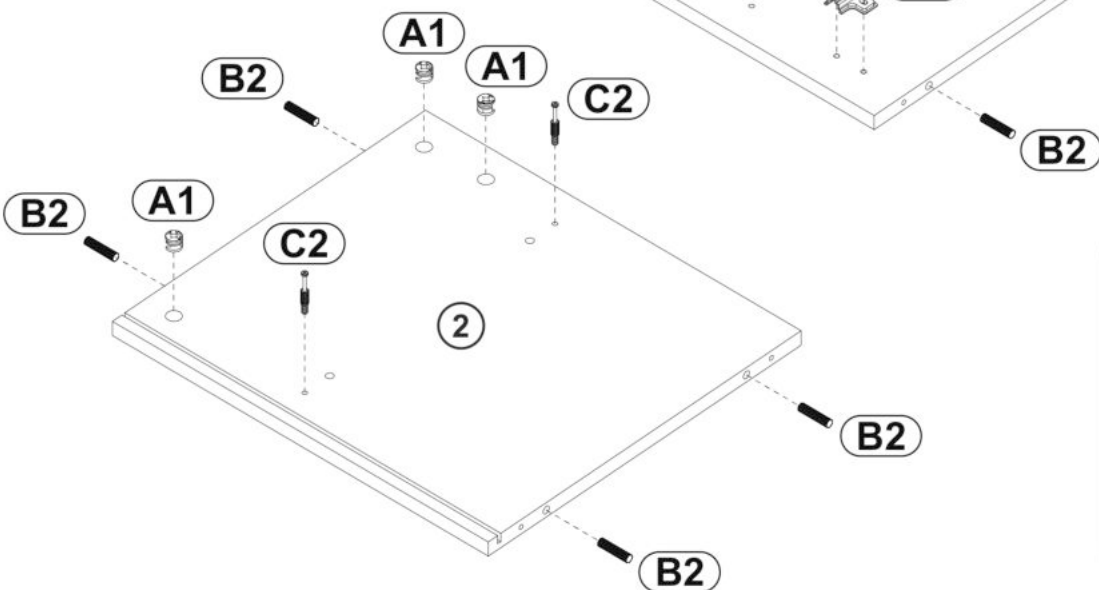
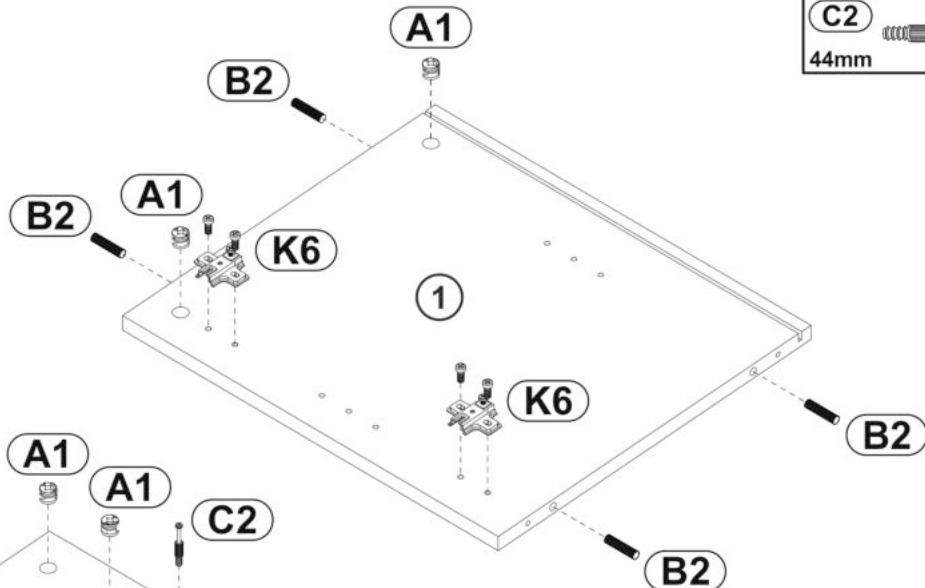
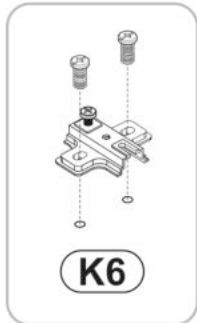

# 4

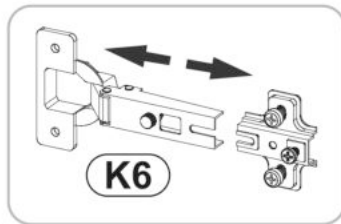
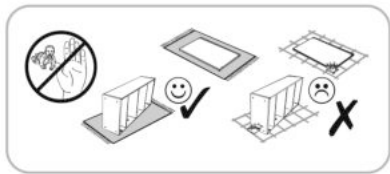

- A1** 15x12 x2
- C2** 44mm x2
- B2** 8x30 x8
- K6** Ø35 x2
- I6** 350 x1
- E5** 5x11 x4

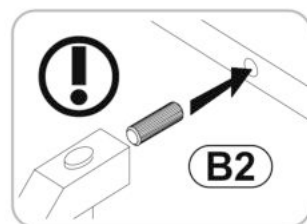
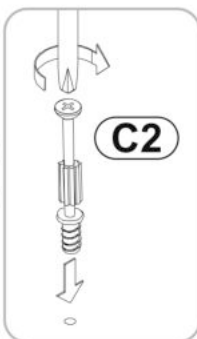
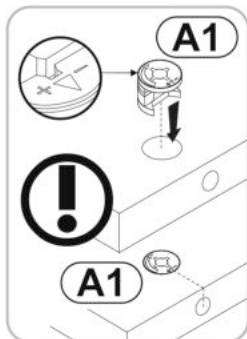
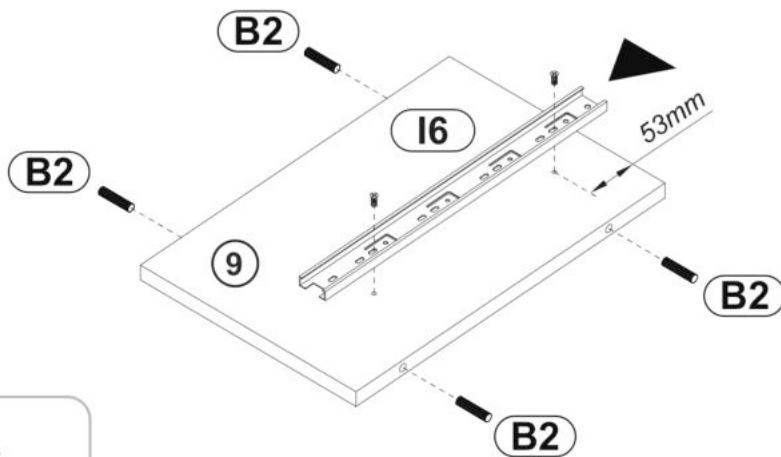
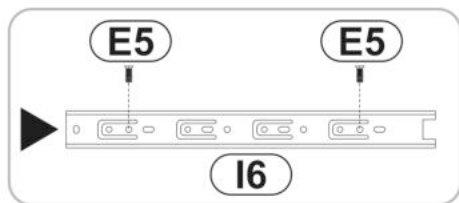
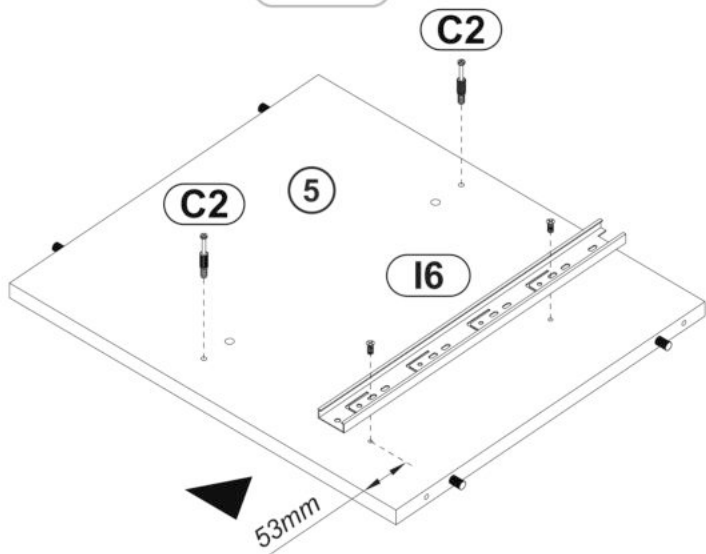
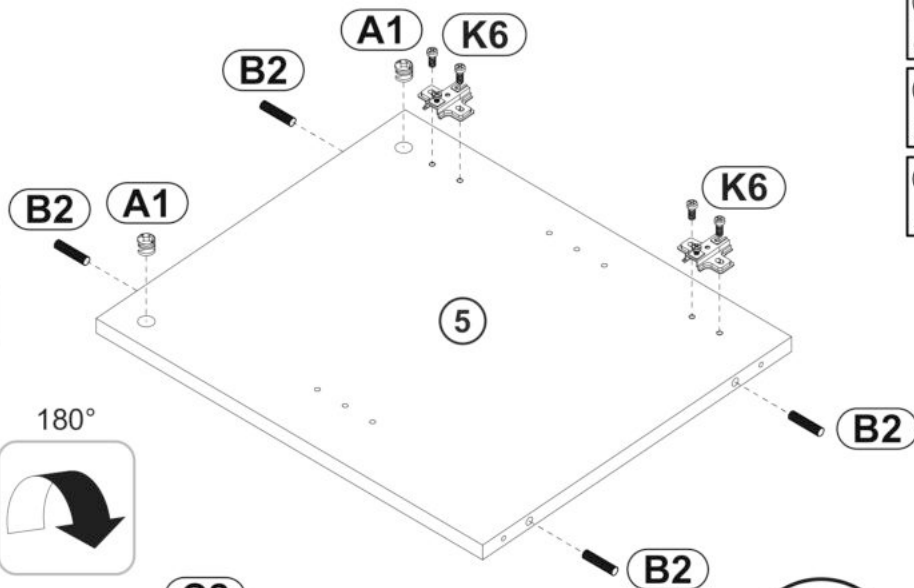
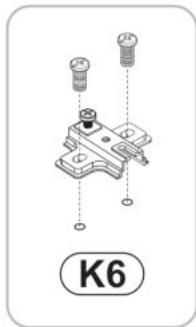

# 5

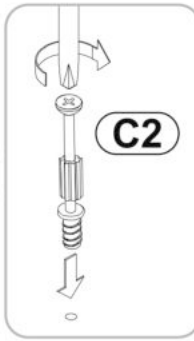
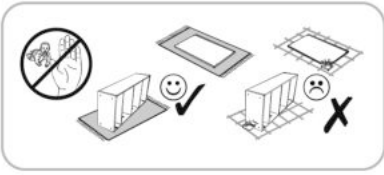

<b>C2</b>		x8
<b>A1</b>		x1
<b>Y36</b>		x1
<b>D11</b>		x2

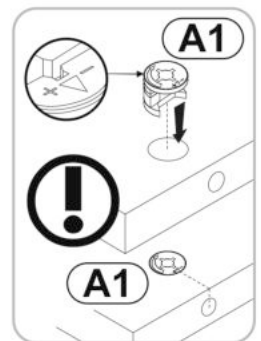
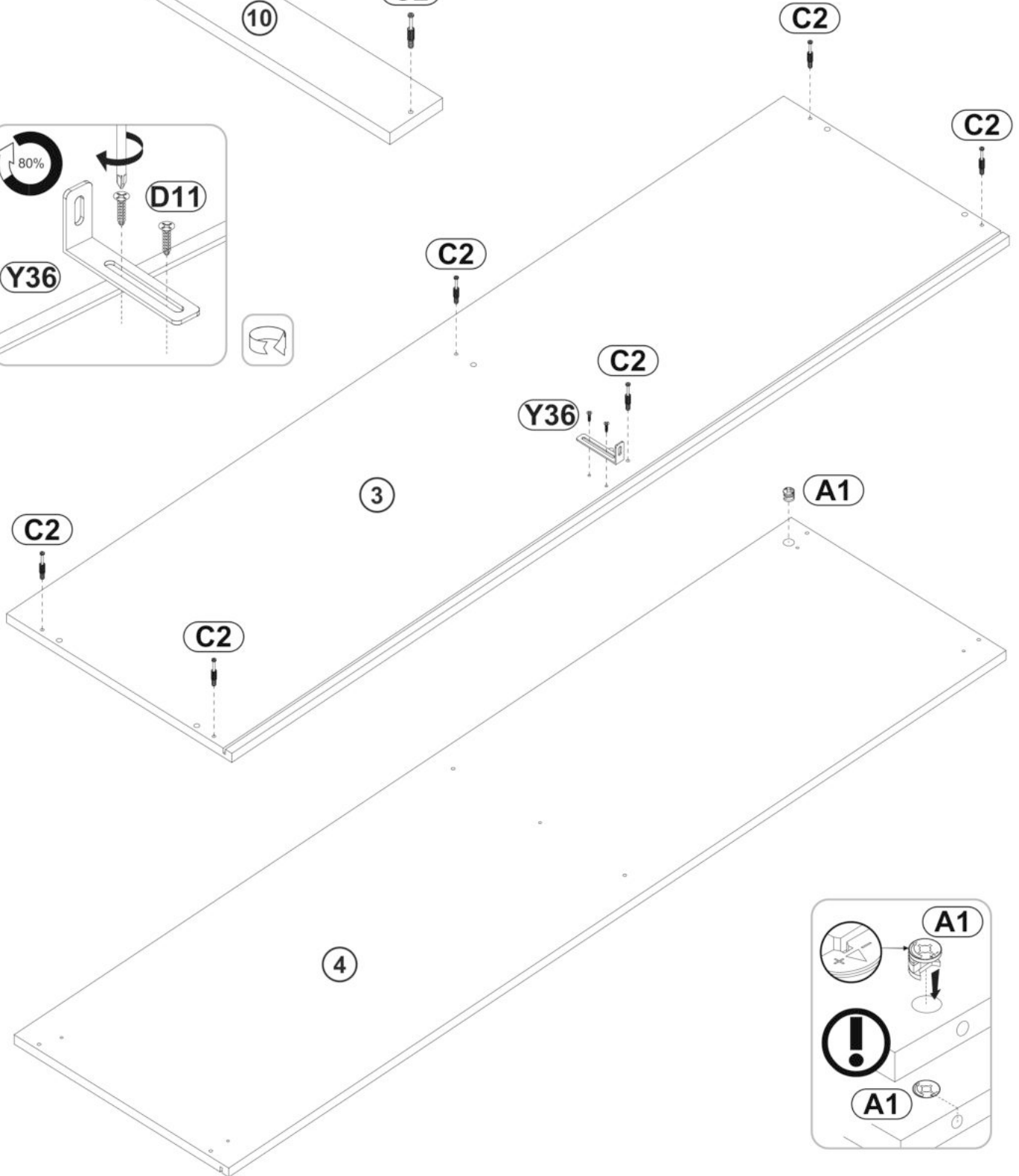
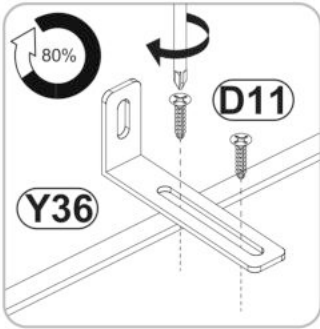
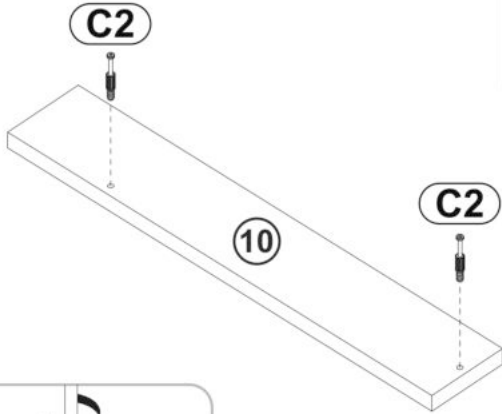

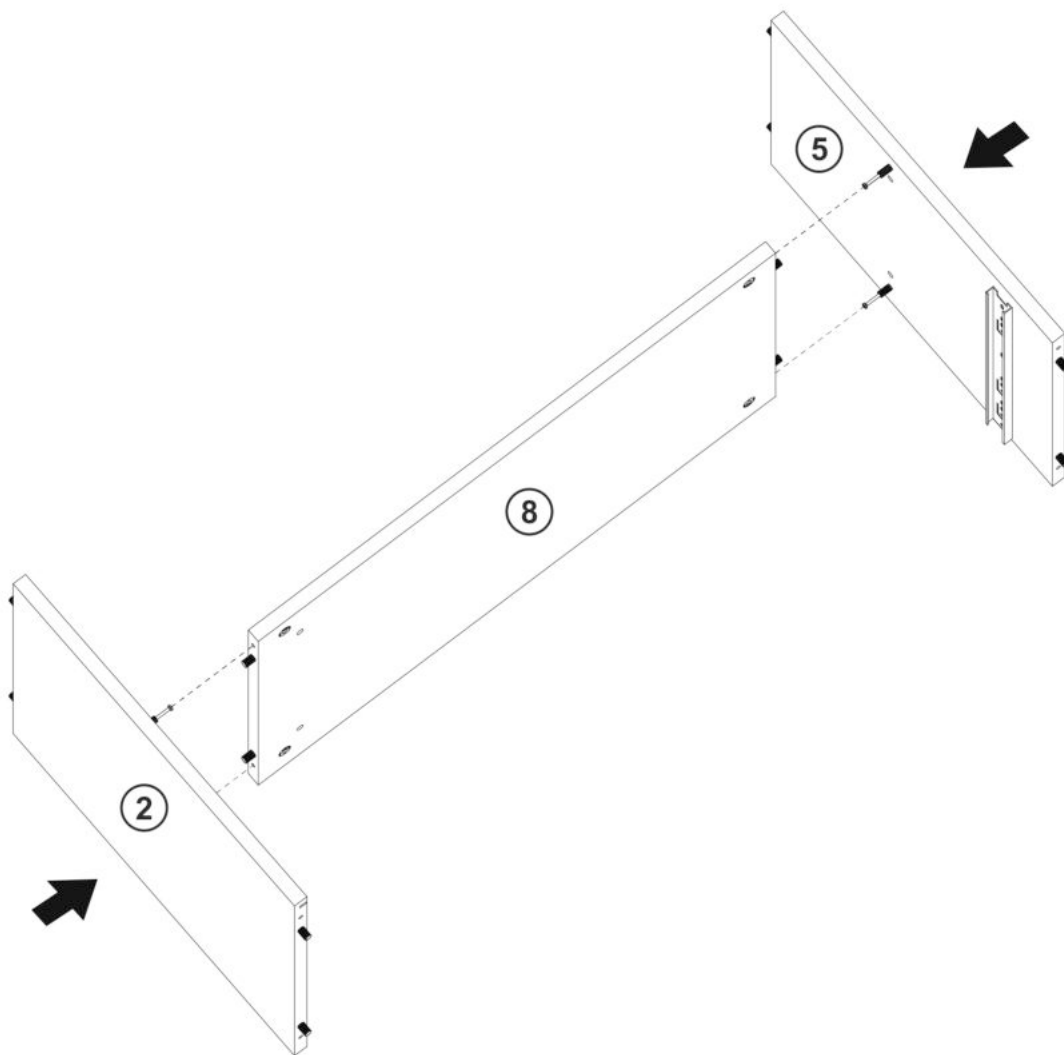
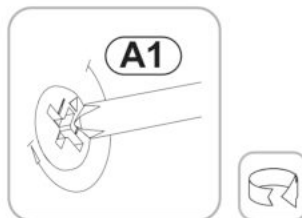
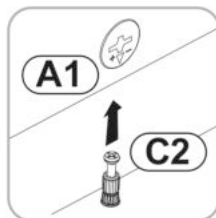
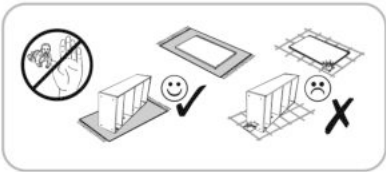

6



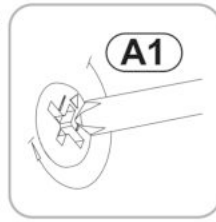
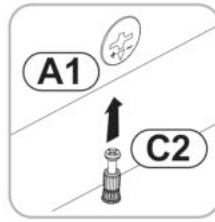
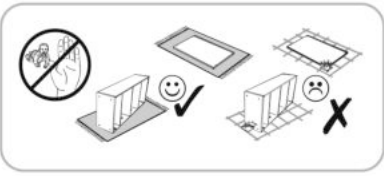

# 7



**O4**  **x4**  
Ø18

**O3**  **x2**  
Ø18

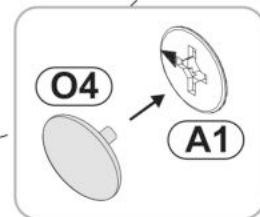
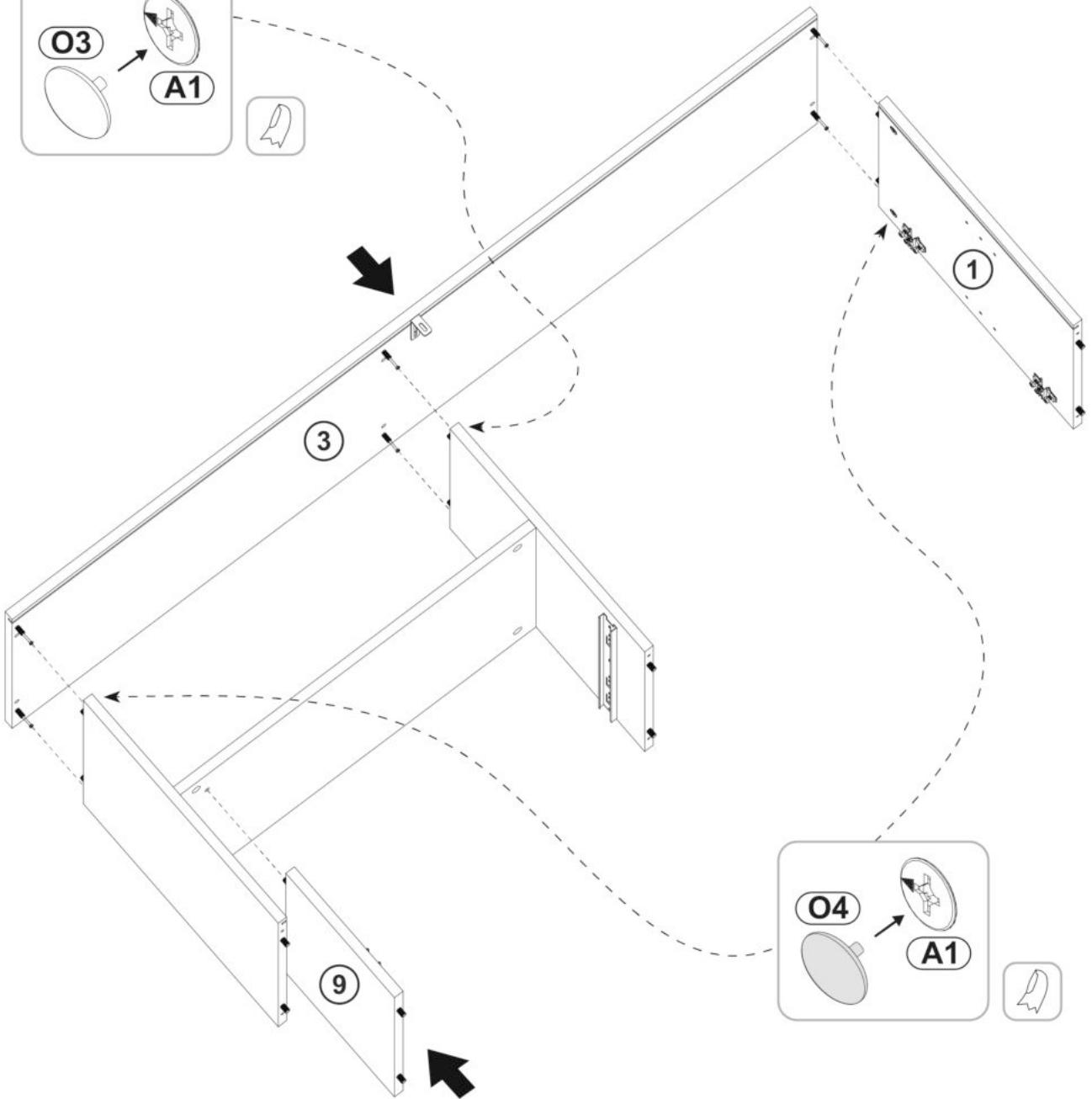
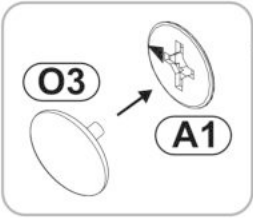

8

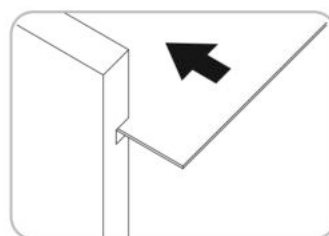
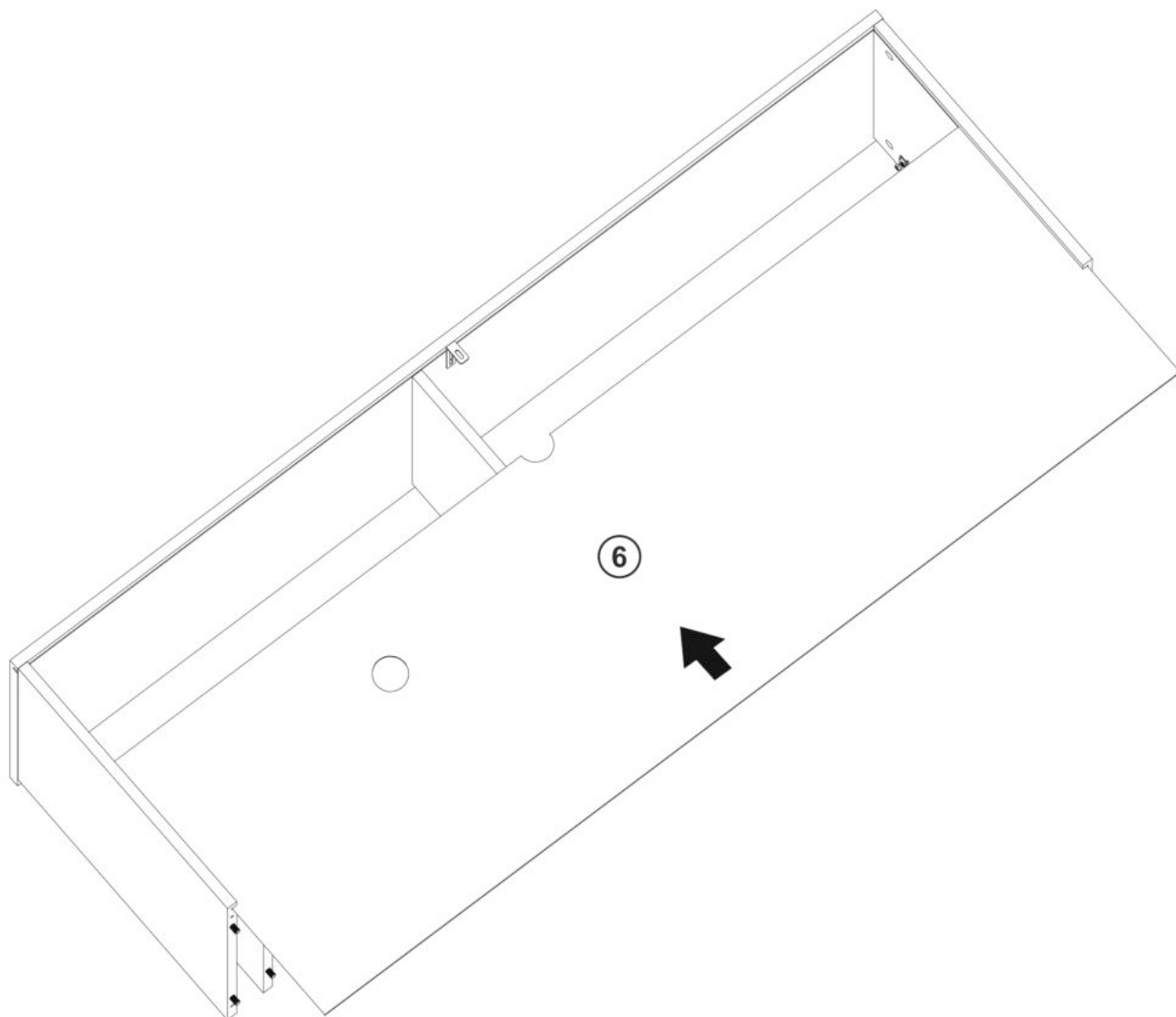
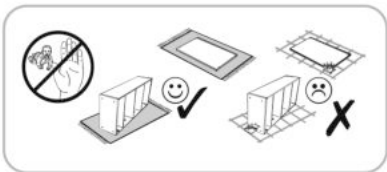

9

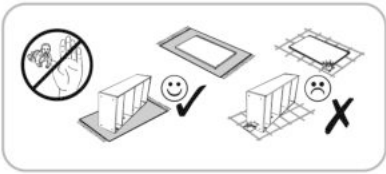

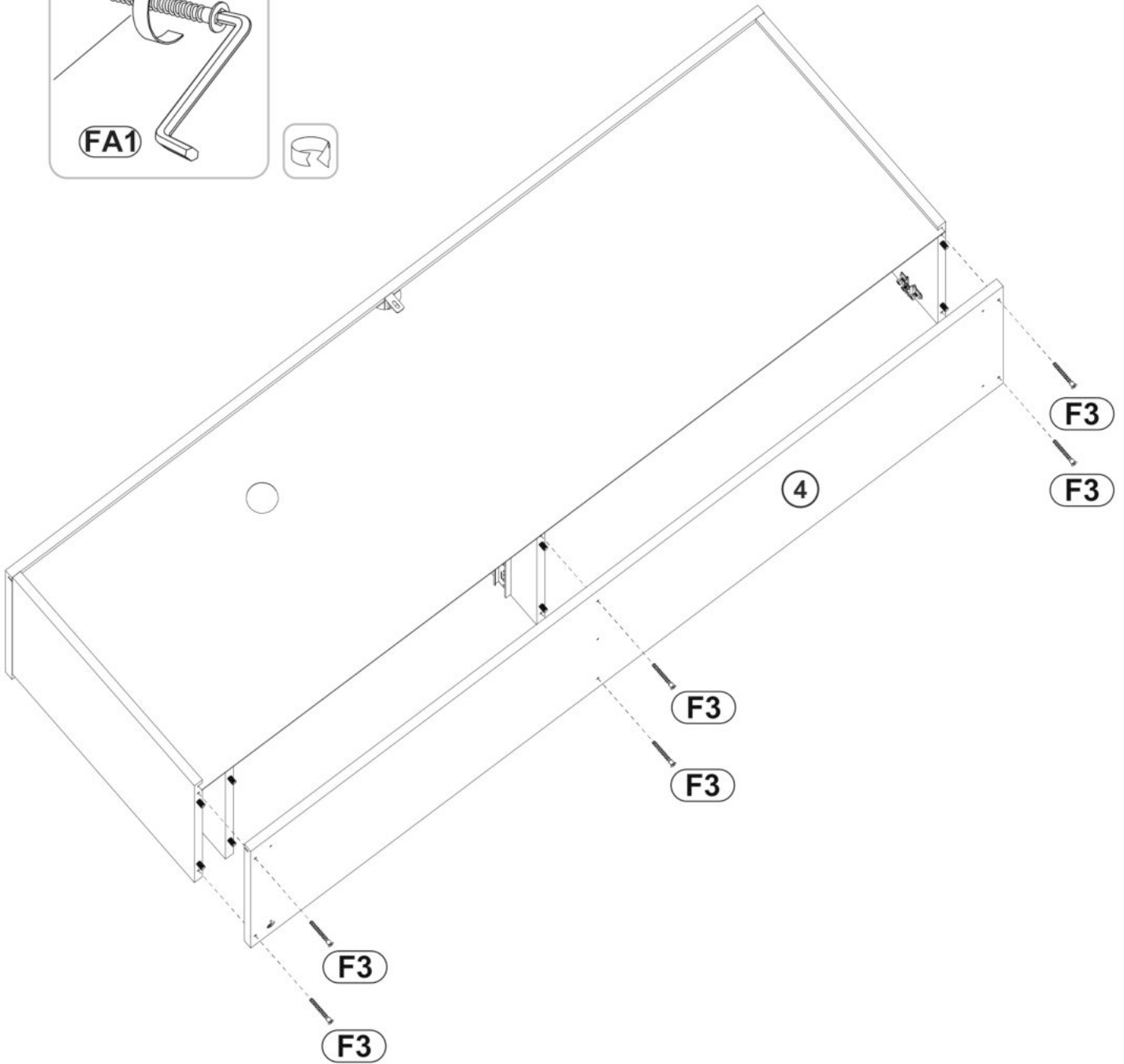
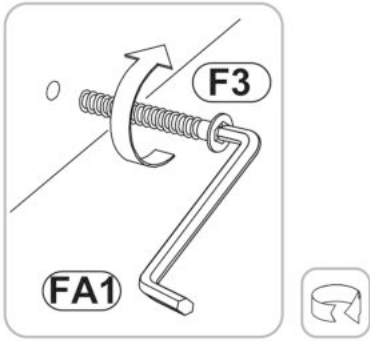

**FA1**  
4mm x1

**F3**  
6,3x50 x6

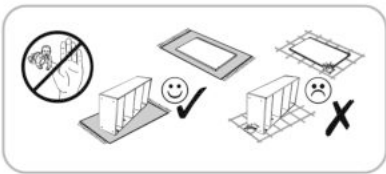

# 10



**O4**  **x1**  
Ø18

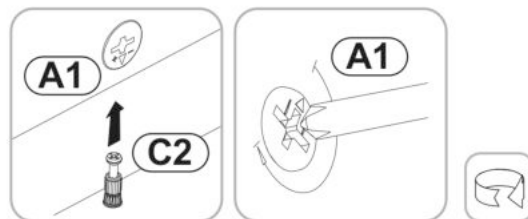
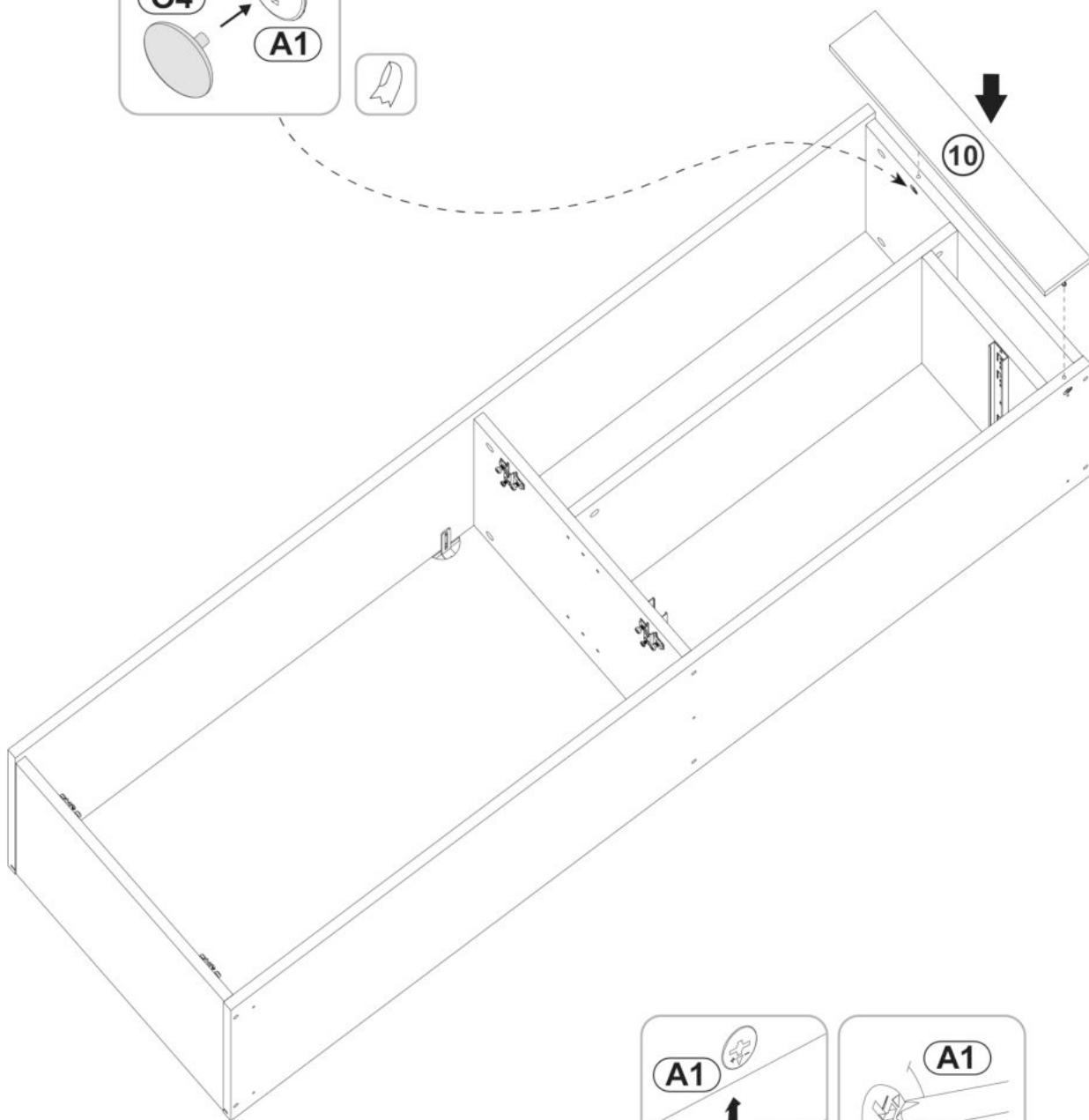
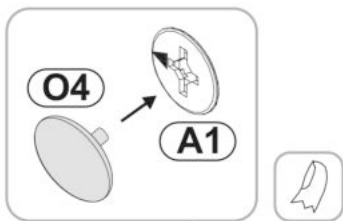

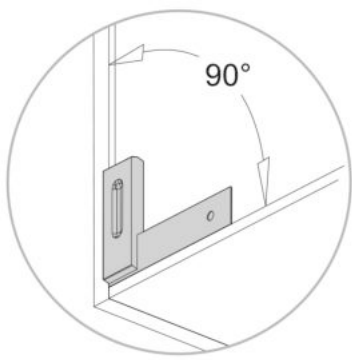
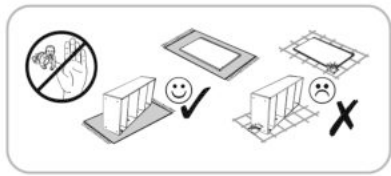

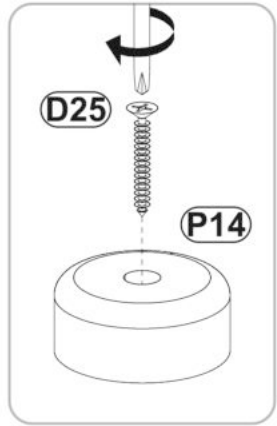
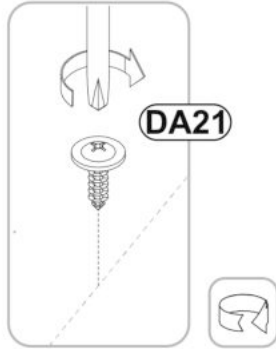
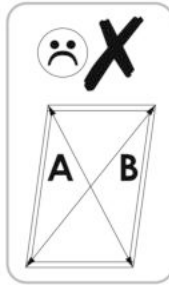
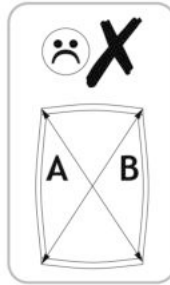
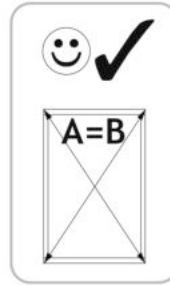
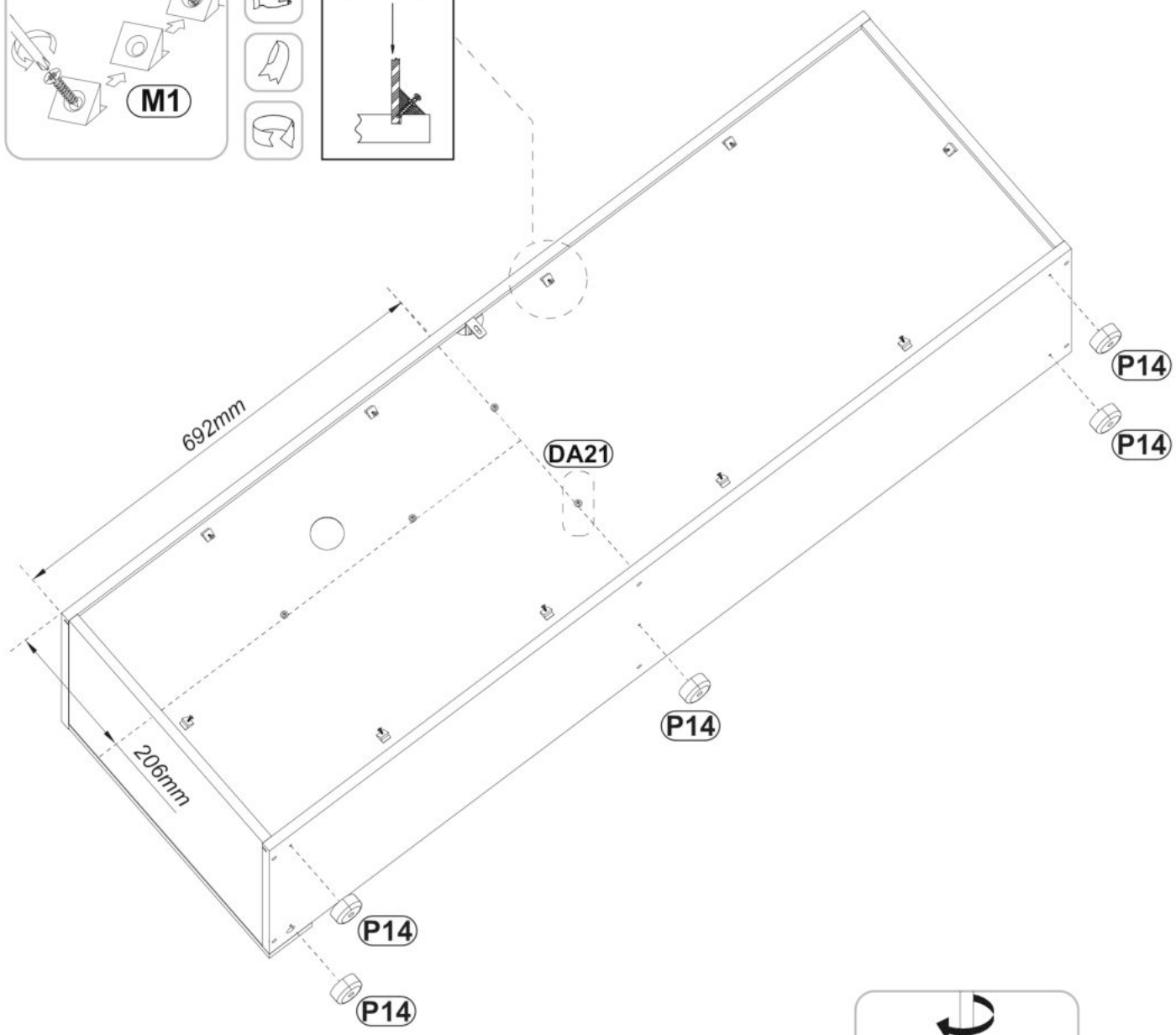
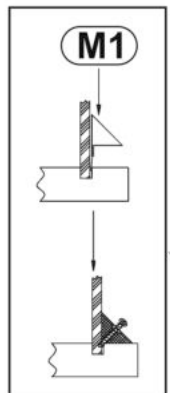
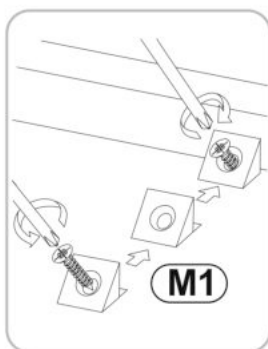

- M1**  
10x10x15 x10
- DA21**  
4,2x16 x4
- P14**  
45x20 x5
- D25**  
4x25 x5

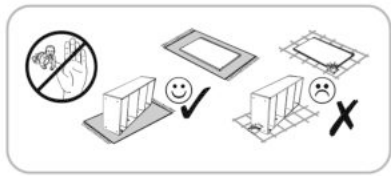





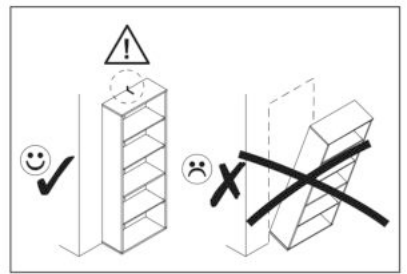
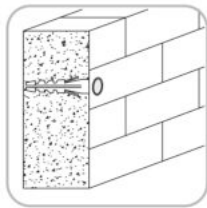
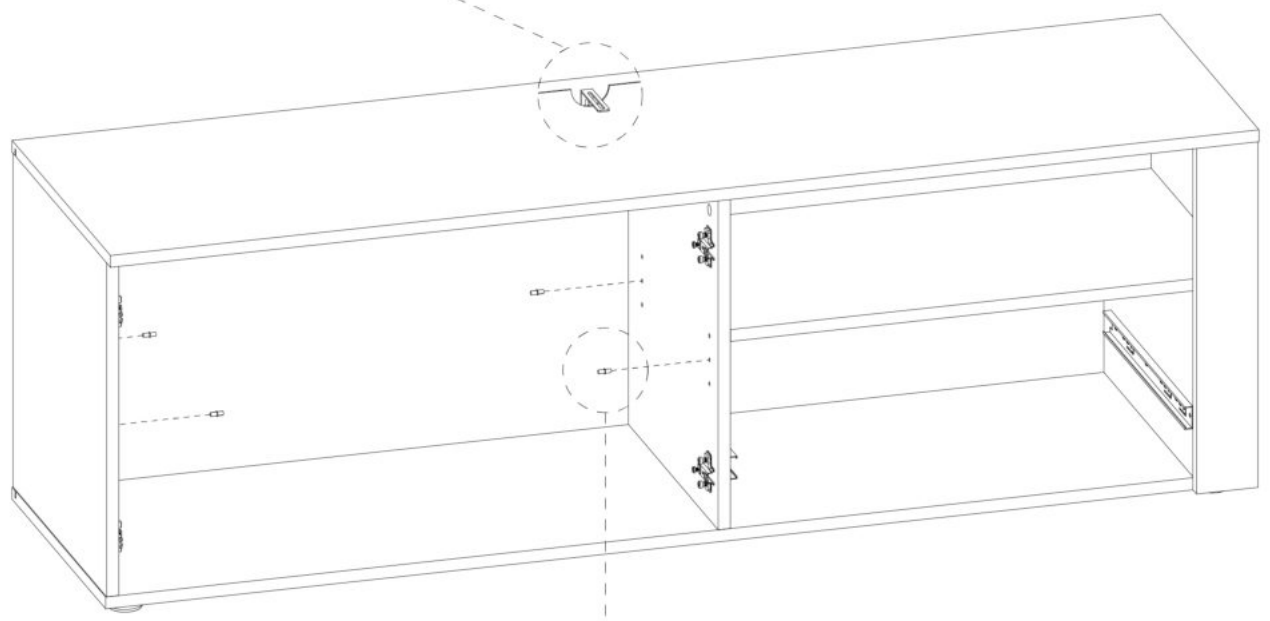
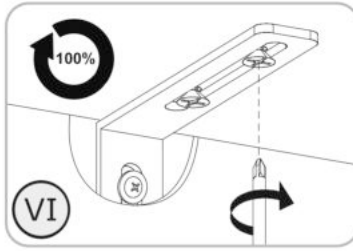
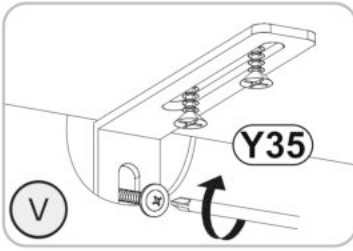
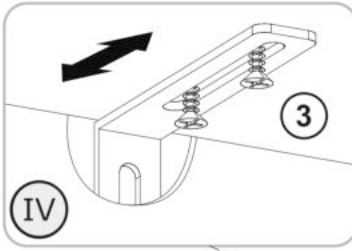
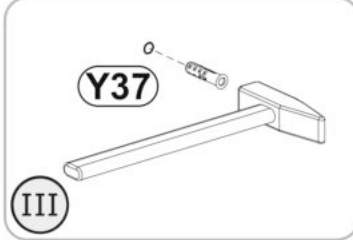
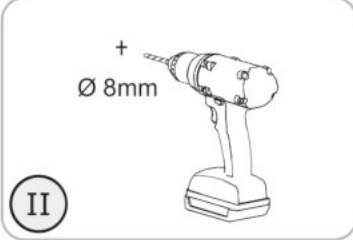
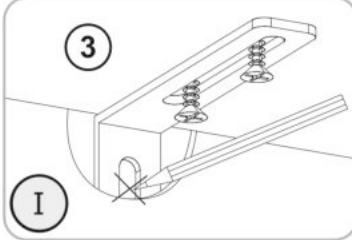

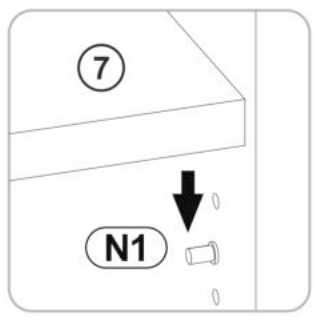
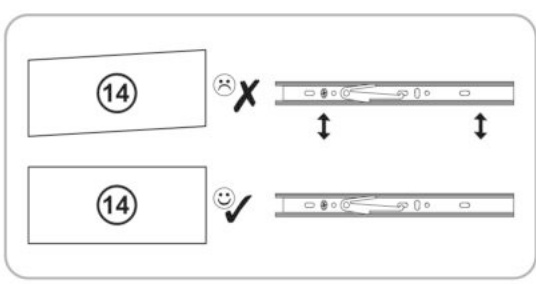
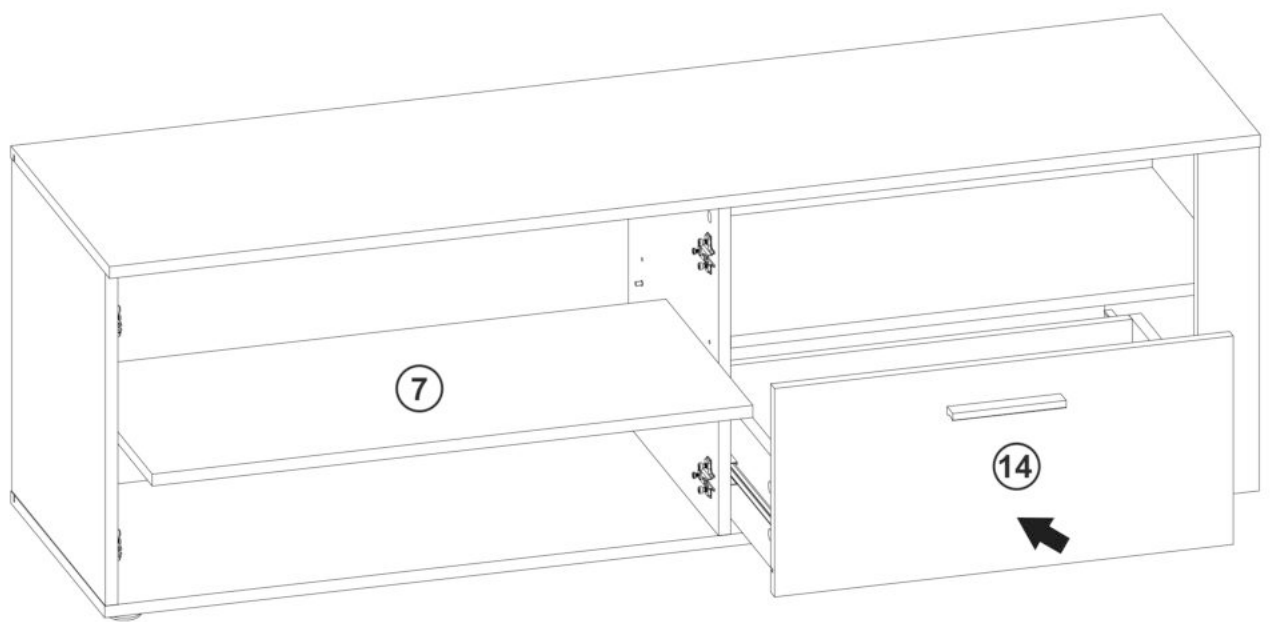
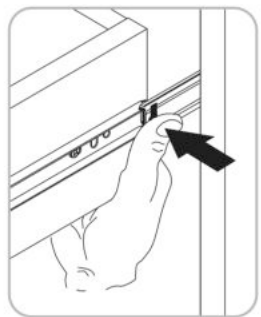
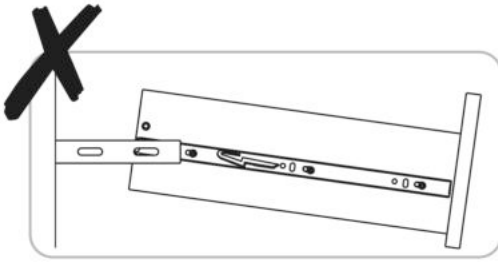
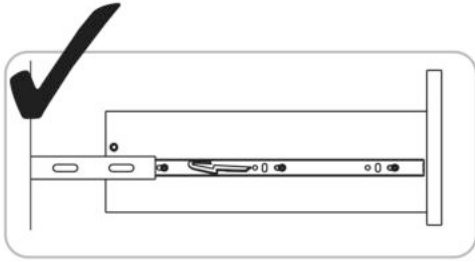
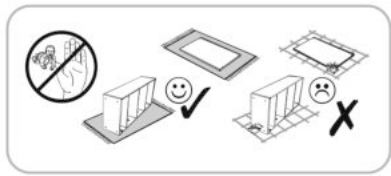
- (N1)**  x4
- (Y37)**  x1
- (Y35)**  x1

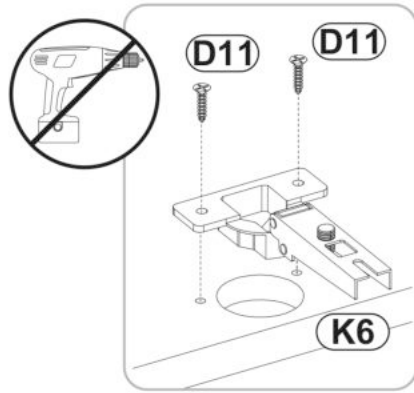
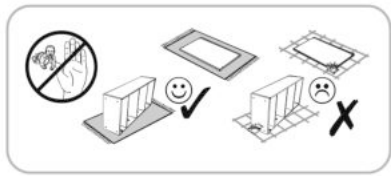

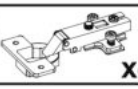



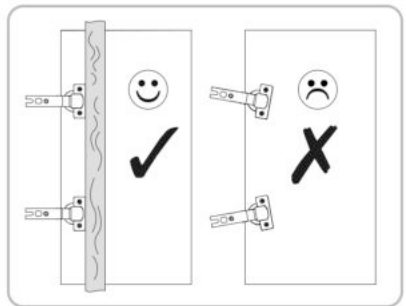
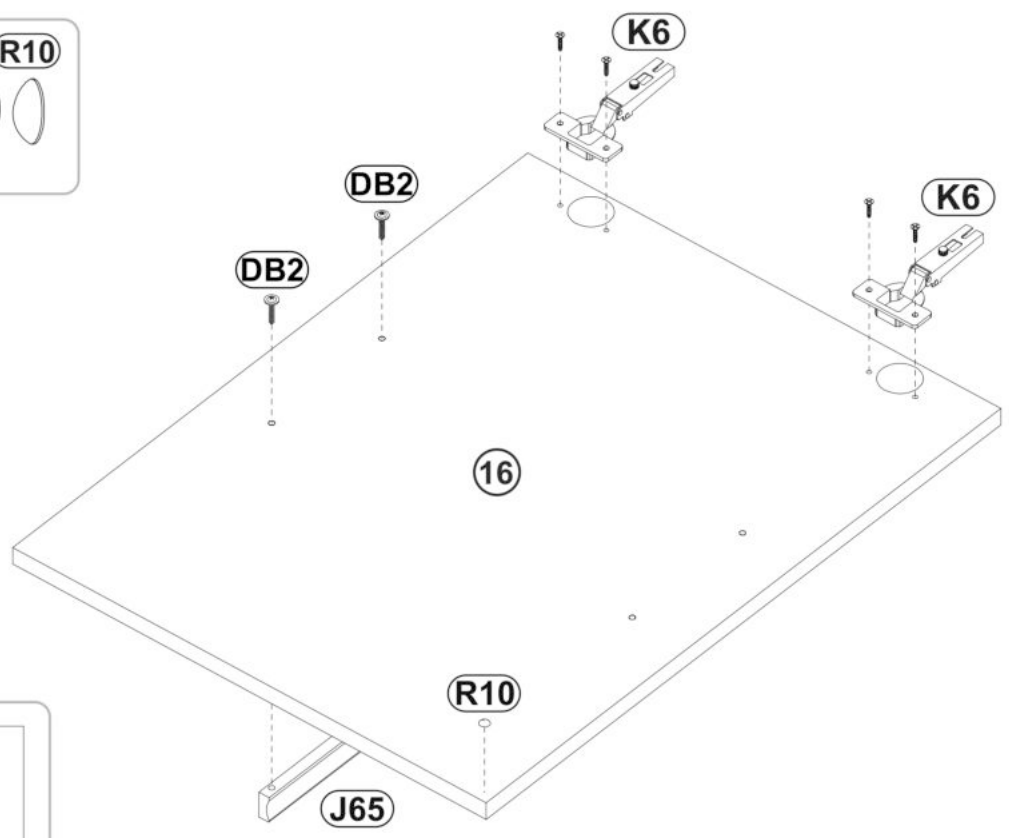
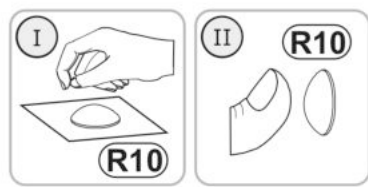
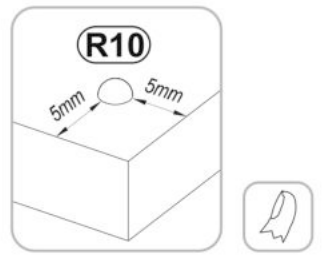
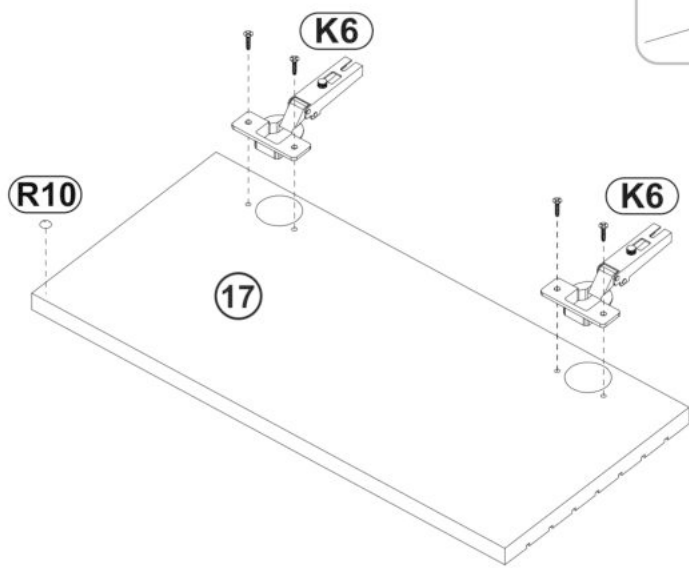

- K6**  x4  
Ø35
- D11**  x8  
3,5x16
- DB2**  x2  
4x25
- J65**  x1  
128/148
- R10**  x2  
Ø10



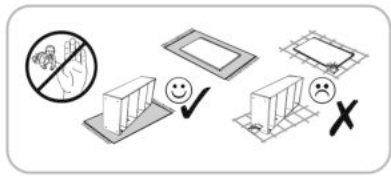

15



R6  x1

